

PRODOTTI / RICAMBI
PRODUCTS / SPARE PARTS
PRODUITS / PIÈCES DÉTACHÉES
PRODUKTE / ERSATZTEILE
PRODUCTOS / REPUESTOS

APPIA 2/3 GRUPPI

23-10-2006



nuova simonelli

COMPONENTI GRUPPO CARENA

A
P
P
I
A

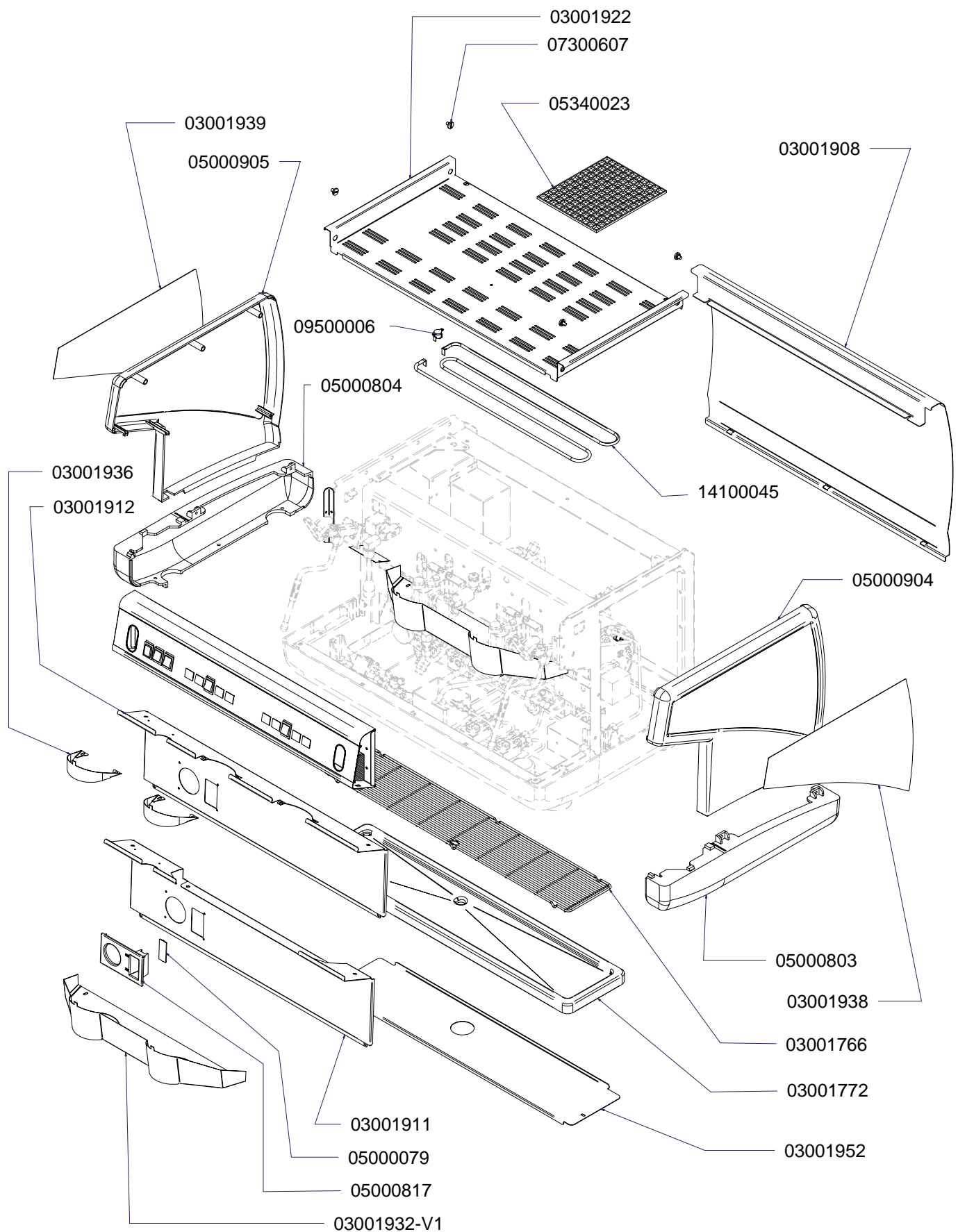

COMPONENTI GRUPPO INVOLUCRO COMANDI

A
P
P
I
A

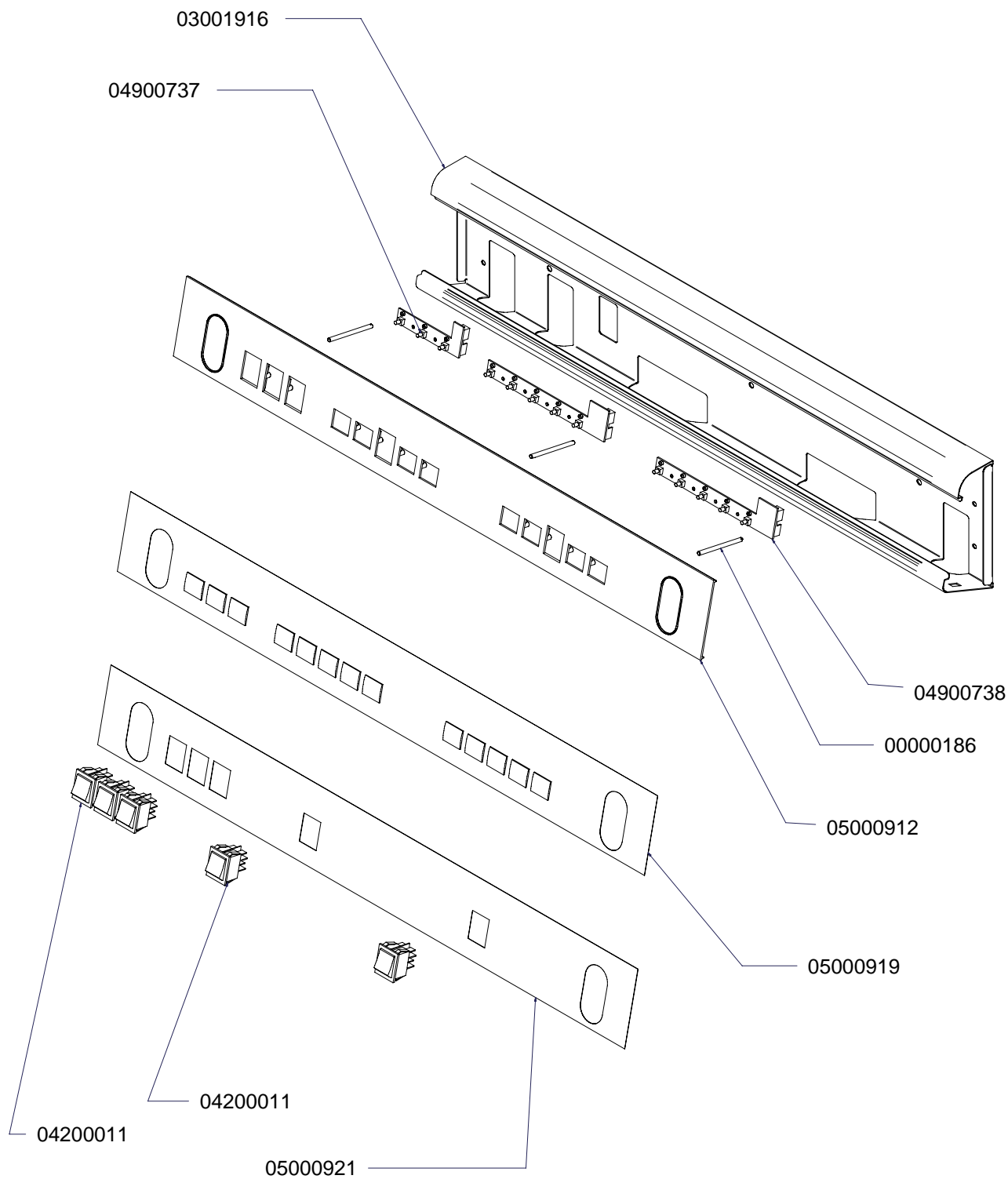

COMPONENTI GRUPPO EROGAZIONE

A
P
P
I
A

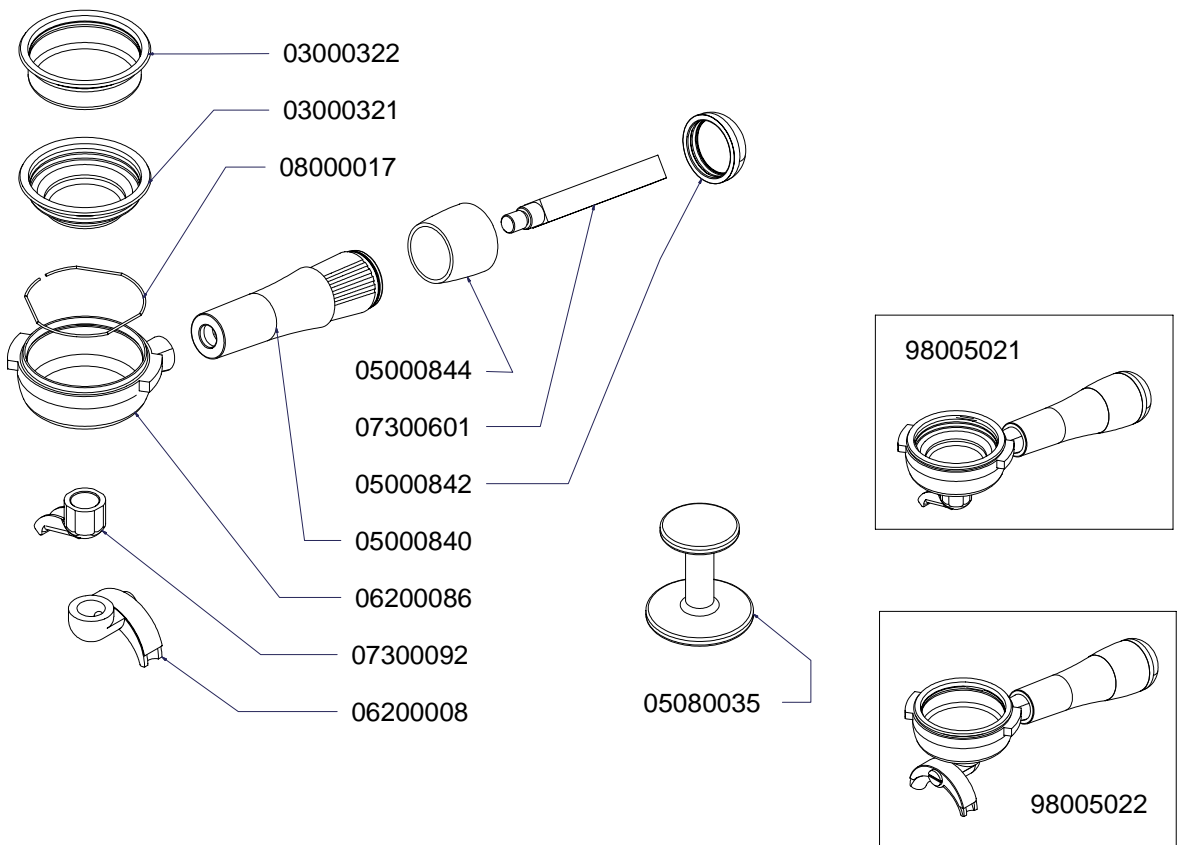
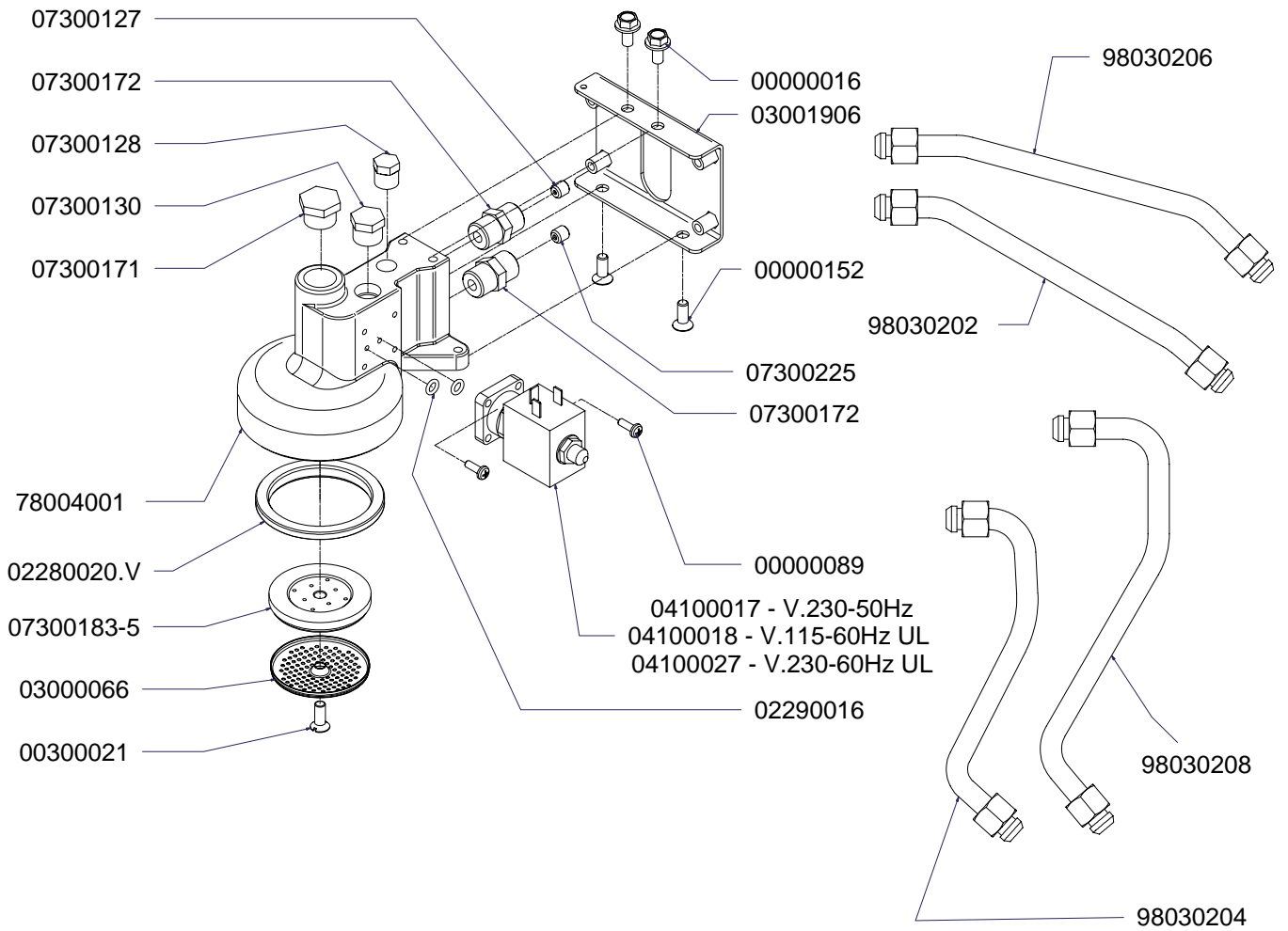

COMPONENTI IDRAULICI

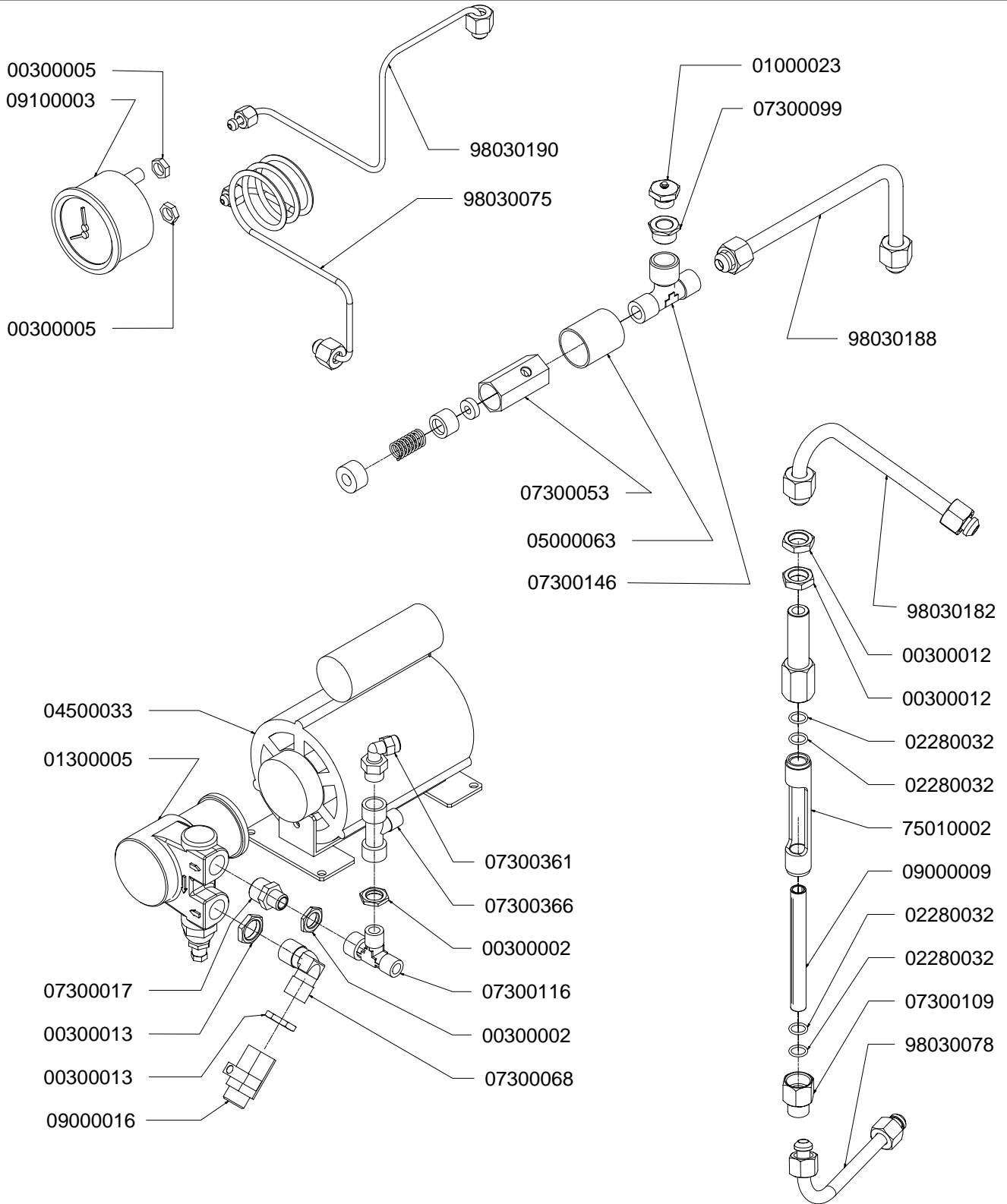

COMPONENTI IDRAULICI

CODICE	DESCRIZIONE	DES ING
01000113	TUBO INGRESSO	Valore
01000012	TUBO SCARICO	Valore
01000087	TUBO SCARICO	Valore
00000086	FASCETTA	Valore
00000133	FASCETTA	Valore

COMPONENTI IDRAULICI 3 GRUPPI

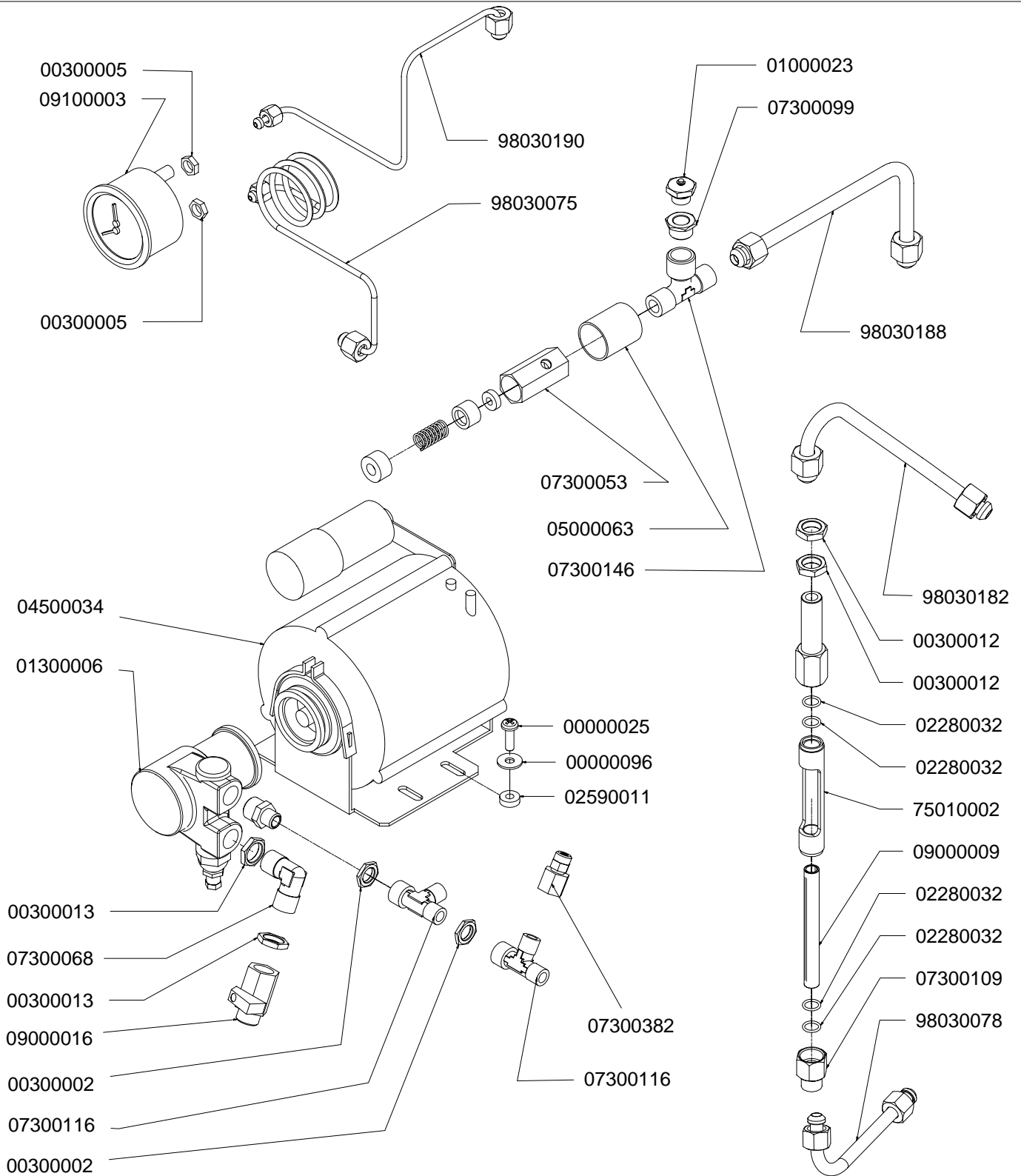

COMPONENTI IDRAULICI

CODICE	DESCRIZIONE	DES ING
01000113	TUBO INGRESSO	Valore
01000012	TUBO SCARICO	Valore
01000087	TUBO SCARICO	Valore
00000086	FASCETTA	Valore
00000133	FASCETTA	Valore



nuova simonelli

TAV 05 BIS

COMPONENTI RUBINETTI VAPORE ACQUA CALDA

A
P
P
I
A

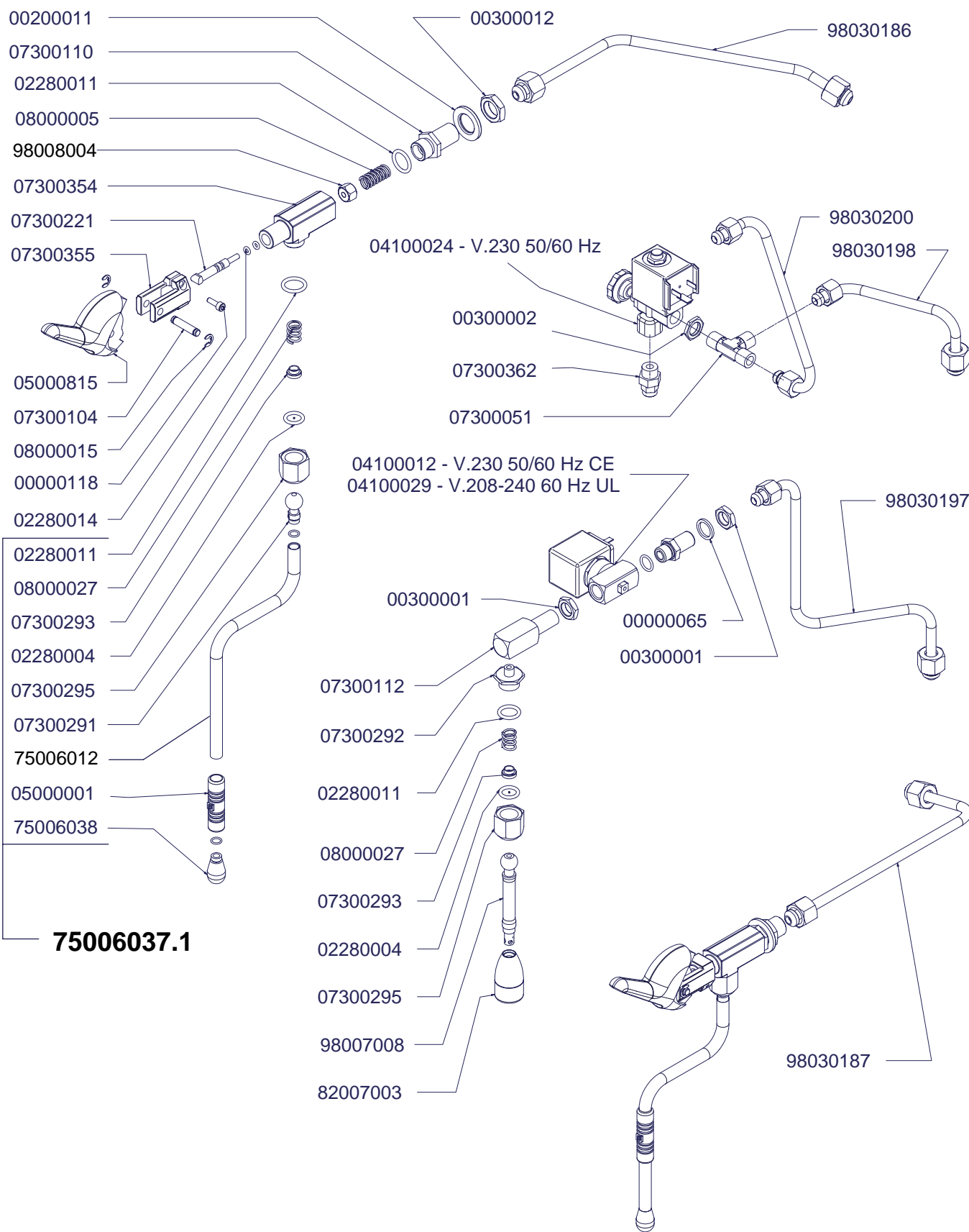

COMPONENTI GRUPPO IDRAULICO

A
P
P
I
A

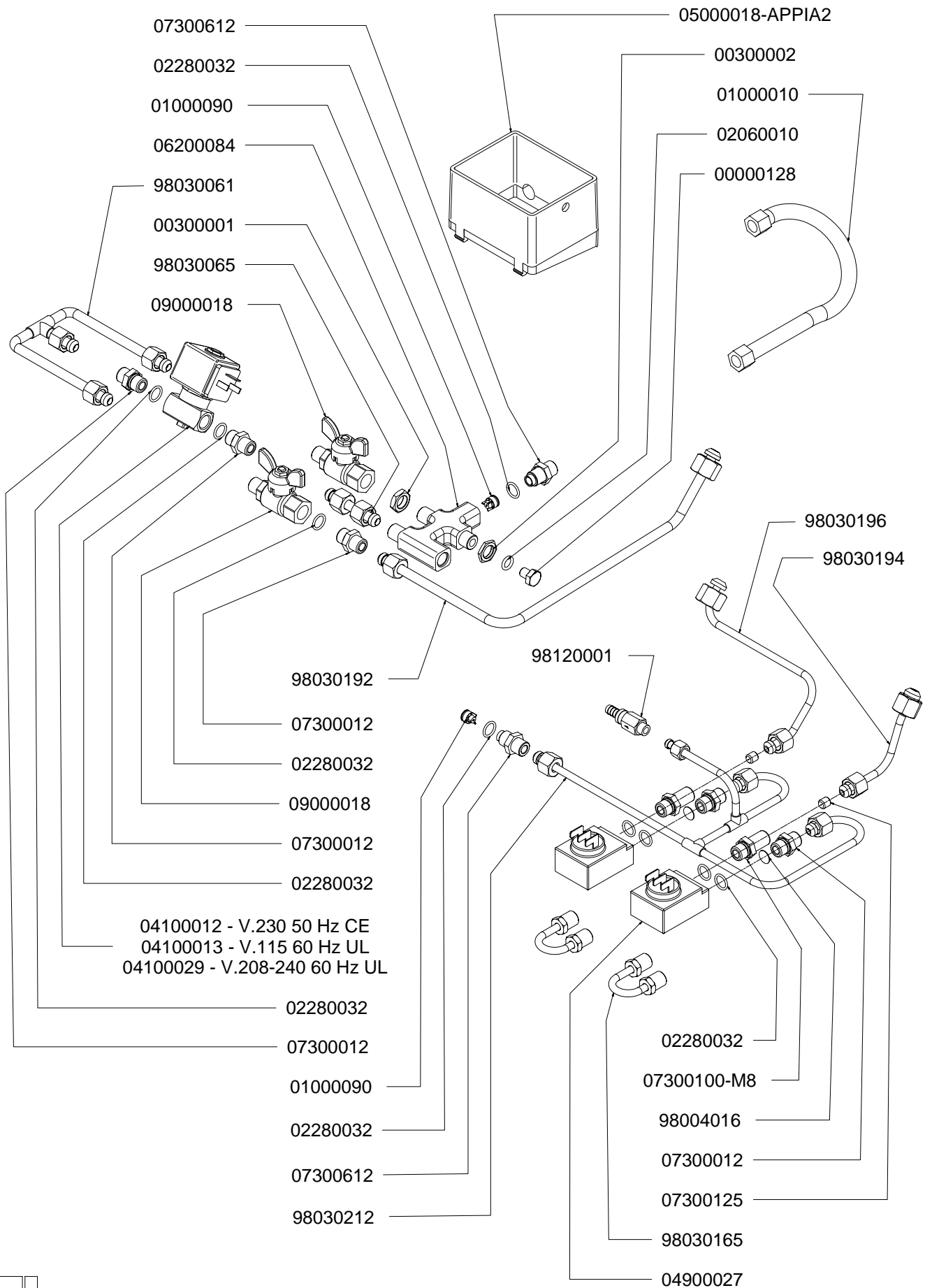

COMPONENTI GRUPPO CALDAIA

A
P
P
I
A

2
G
R

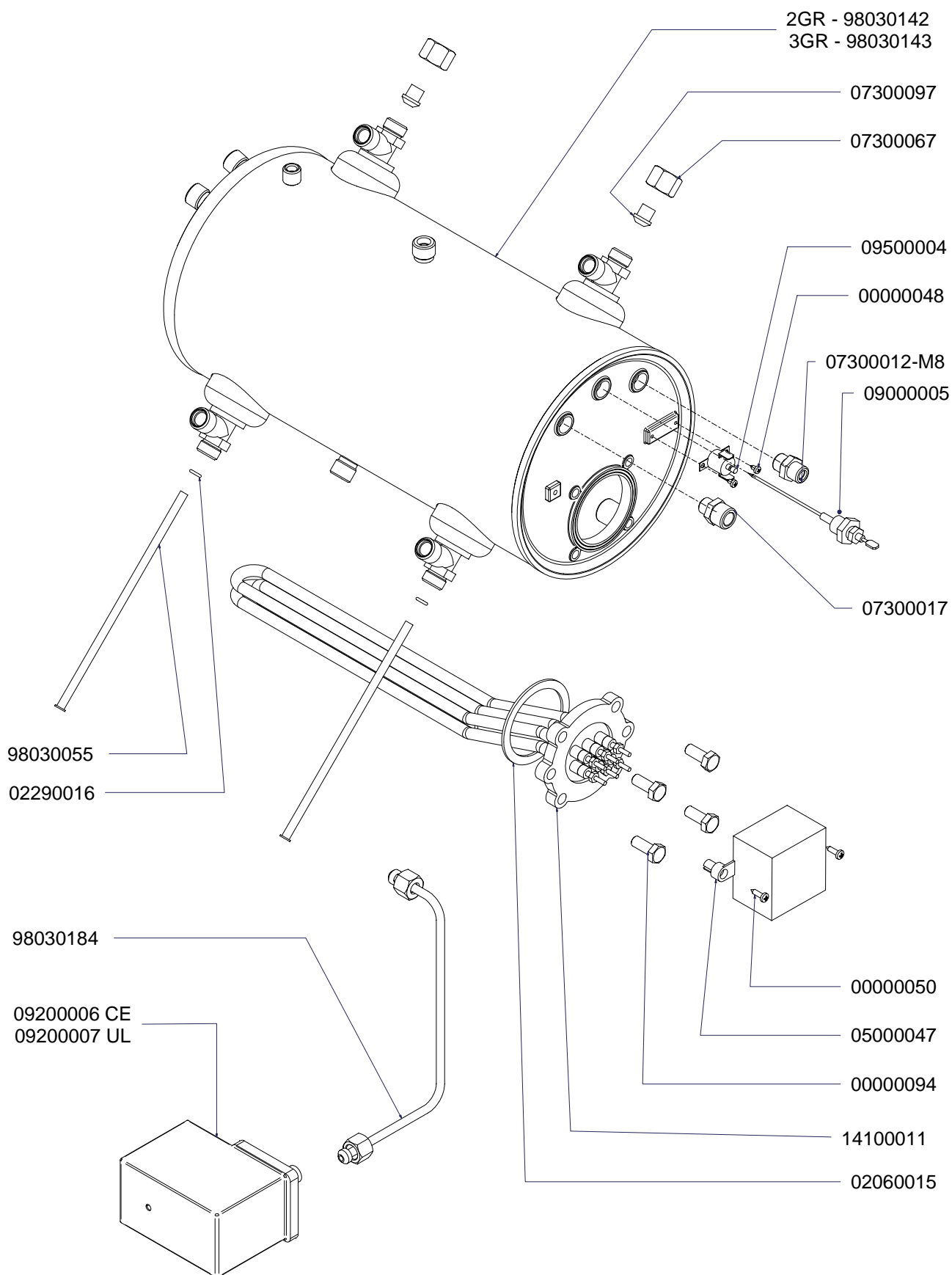

COMPONENTI TELAIO 2-3 GRUPPI

A
P
P
I
A

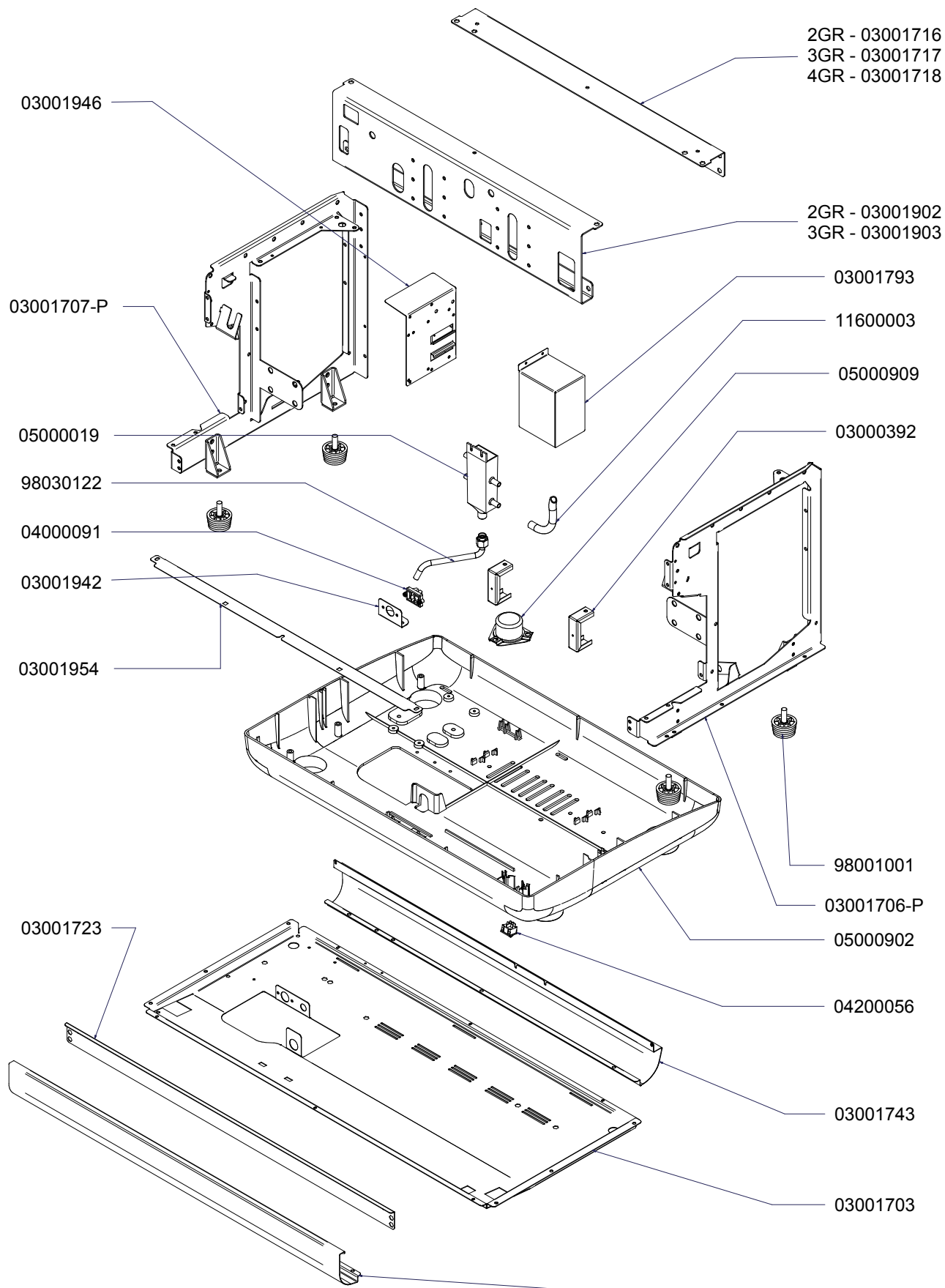

nuova simonelli

TAV 10

COMPONENTI ELETTRICI

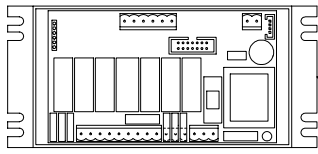

2GR - 04900732

3GR - 04900733

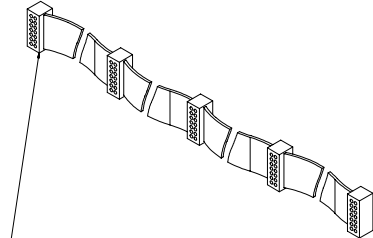
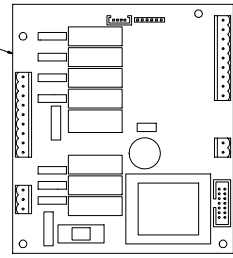

2 GR - 04000812
3 GR - 04000813

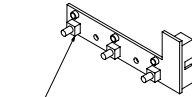

04900737

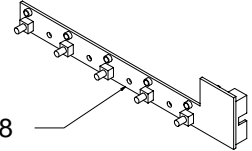

04900738

2GR - 05000919
3GR - 05000923

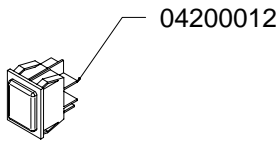
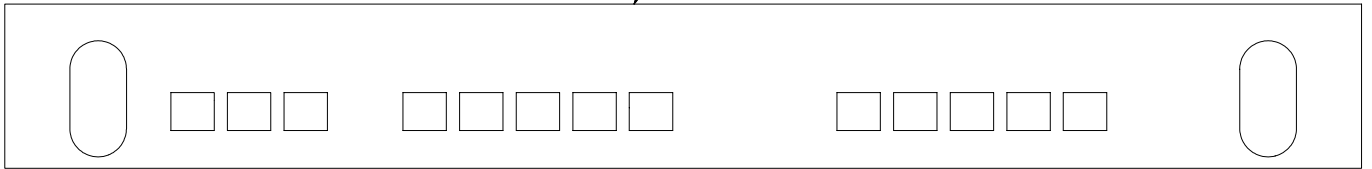

04200012

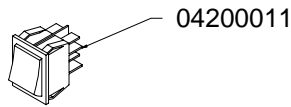

04200011

2GR - 05000921
3GR - 05000922

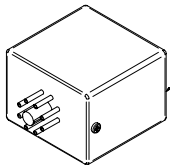

09000004 V110
09000015 V220

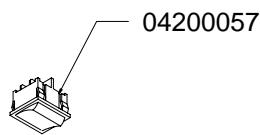

04200057

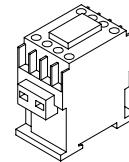

04200019

COMPONENTI ELETTRICI

COD.	DESCRIZIONE	DES. ING.
04000805	IMPIANTO ELETTRICO V.	Valore
04000807	IMPIANTO ELETTRICO S.	Valore
04000806	IMP.ELETTRICO SCALDATAZZE	Valore
04000807.P	IMP. ELET. PULSANTIERA S.	Valore
XXXXXX	XXXXXXXXXX	Valore
XXXXXX	XXXXXXXXXXXX	Valore